



DATA SHEET



LK6FSTL

Full shielded CAT6 tool less RJ45 modular jack - Link+ range



Benefits +

- Tool less CAT6 RJ45 modular jack
- Link compliant
- Low depth

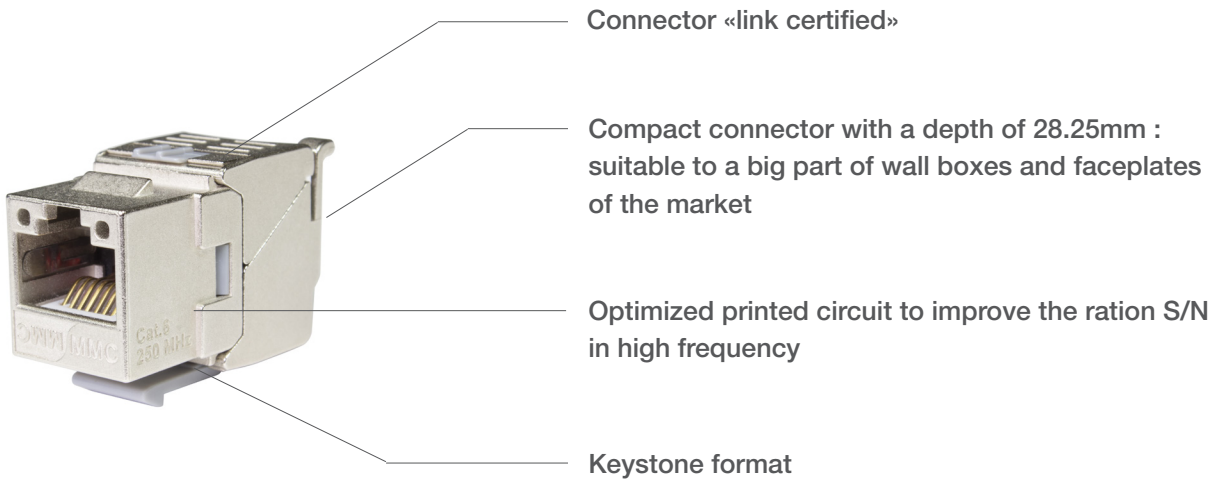

Wiring cap offering color code TIA 568B

Translucent wiring cap to facilitate the visual cabling inspection

Termination through wiring cap equipped with an insert to facilitate the wire management reduce the untwisted lenght : optimisation of the NEXT value

Two wings to offer a simple connector locking (no loose part)

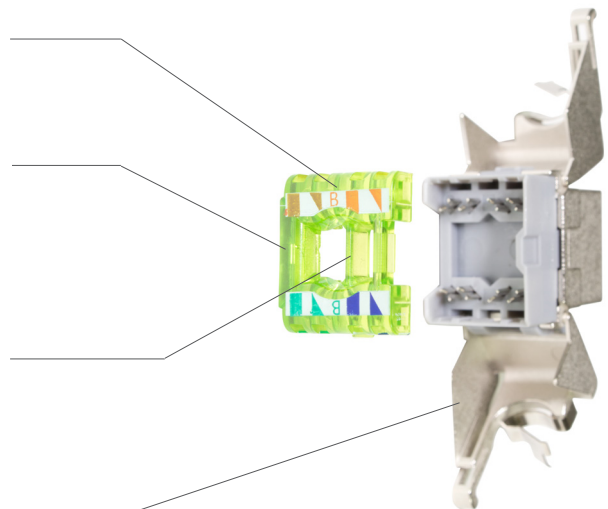

This document is confidential, and is the property of CAE GROUPE. CAE GROUPE own the copyright, and the document must not be copied or changed in any form, wholly or in part without written permission from CAE GROUPE. The contents of this document must be disclosed to any other person or persons. The characteristics related to this document are not contractual, and can be modified without warning.



DATA SHEET



LK6FSTL

Full shielded CAT6 tool less RJ45 modular jack - Link+ range

PERFORMANCES

CONNECTOR	SYSTEM
IEC 60603-7-5 CAT6	TIA 568-C.2 CAT6
FCC Part 68 subpart F	ISO 11801 Ed2.2 Class E
TIA 570-B	EN 50173-1
UL 18663	IEEE 802.3af & at (PoE / PoEP)

TECHNICAL PROPERTIES

IDC :	Bronze + Platine / Cu + SnPb 80μ
Solid and flexible wires	AWG 26 to AWG 23
Maximum insulation diameter :	1.3 mm
Maximum cable diameter :	8.5mm
Contacts :	Bronze, Platine Ni and Au 1.2μm
Body	ZAMAC
Color code	568 B

ELECTRICAL PROPERTIES

Contact resistance :	< 20 mΩ IEC 60512-2-1 Test 2a
Input/Output resistance :	< 200mΩ IEC 60512-2-1 Test 2a
Insulation resistance :	> 500MΩ @100V DC IEC 60512-3-1 Test 3a
Voltage :	> 1000V DC contact to contact > 1500V DC contact to ground (IEC 60512-4-1 Test 4a Method A)
Insertion cycle :	> 1000
Operating voltage :	< 72V DC
Capacity of power :	< 30W
Operating Temperature :	-40°C to +70°C



This document is confidential, and is the property of CAE GROUPE. CAE GROUPE own the copyright, and the document must not be copied or changed in any form, wholly or in part without written permission from CAE GROUPE. The contents of this document must be disclosed to any other person or persons. The characteristics related to this document are not contractual, and can be modified without warning.



LK6FSTL

Full shielded CAT6 tool less RJ45 modular jack - Link+ range

3D DRAWINGS

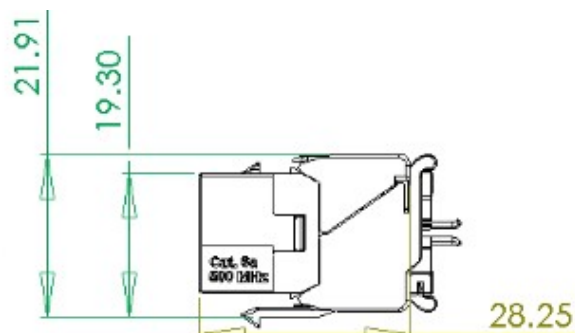
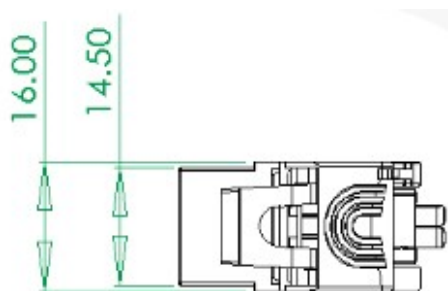







ORDERING INFORMATION

P/N	DESCRIPTION	PACKING
LK6FSTL8	Tool less full shielded CAT6 RJ45 modular jack - Link+ range	8

Individual polybag
Weight 20g



ORDER	PACKING LEVEL	QUANTITY	PICTURE PACKING
If quantity is nx8 pcs 	Transparent polybag 140x200 Total Weight 160g	8 pcs	
If quantity is nx48 pcs 	Printed carton box 230x230x70 Total Weight 1.1Kg	48 pcs	
If quantity is nx480 pcs 	Neutral brown carton 750x237x250 Total Weight 12Kg	480 pcs	
If quantity is nx9600 pcs 	Wood pallet 800x1200x1100 Total Weight 241Kg	9600 pcs	